

S P E C I F I C A T I O N S

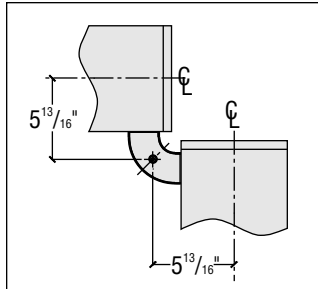

DCS - 90° CONNECTOR

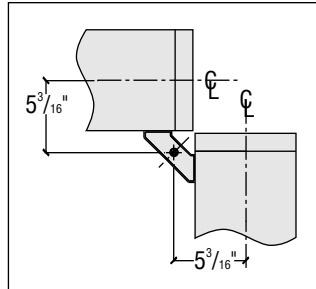

DRS - 90° CONNECTOR

Delgada Series

Curved Housing (DCS) 7 5/8" x 2"

Rectangular Housing (DRS) 7 5/16" x 2"

Construction

One piece die-cast aluminum.

Finish

Standard and premium finishes are baked powder coat electrostatically applied (2.0 mil. minimum thickness) to assure aesthetics and durability.

H O W T O O R D E R

Standard Connectors are 2-way 90°

Catalog Logic

All connectors should be specified and ordered as follows:

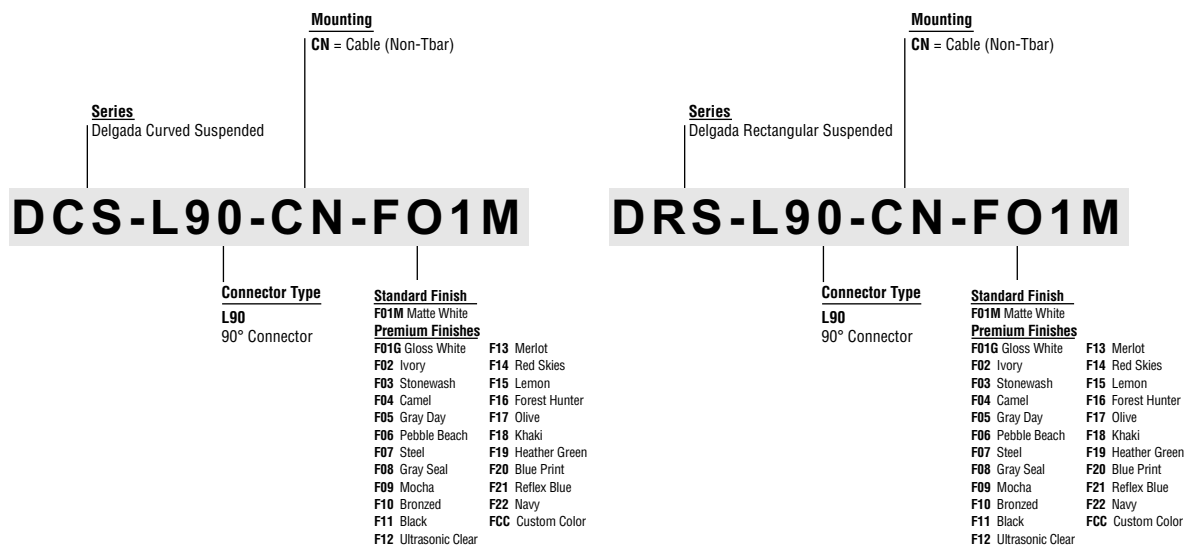

Delgada Series

Standard Fixture Lengths and Mounting Centers

Cable Mount - Indirect/Direct Configurations

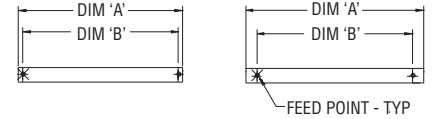
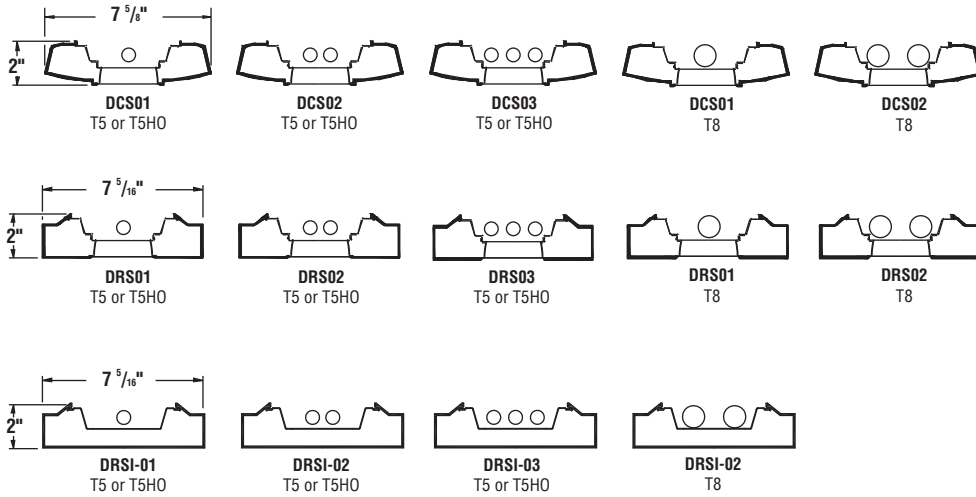

FLAT END OPTION		
DCS	MOUNTING CENTERS	DRS
FIXTURE LENGTH	DIM 'B'	FIXTURE LENGTH
DIM 'A'	DIM 'B'	DIM 'A'
49 1/4"	48"	50 1/2"
97 1/4"	96"	98 1/2"

EXTENDED END OPTION		
DCS	MOUNTING CENTERS	DRS
FIXTURE LENGTH	DIM 'B'	FIXTURE LENGTH
DIM 'A'	DIM 'B'	DIM 'A'
57"	48"	57"
105"	96"	105"

Wall Mount - Indirect/Direct Configurations

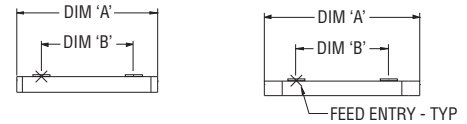
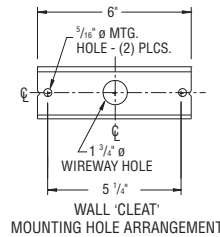
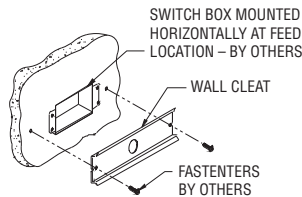
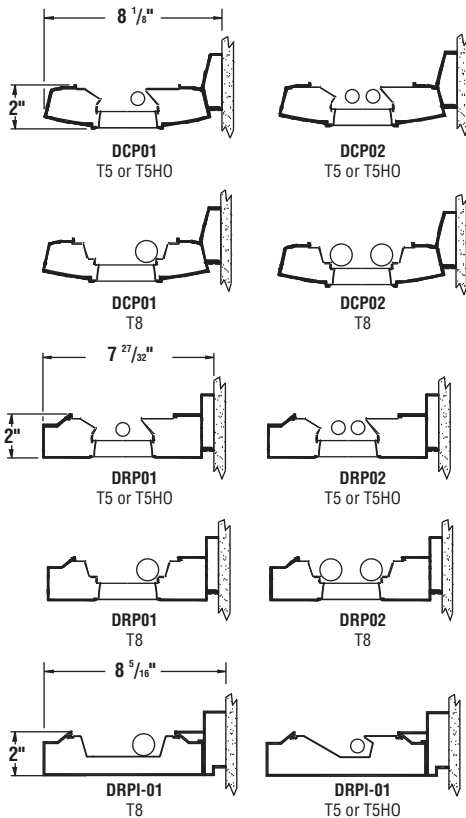

FLAT END OPTION		
DCP	MOUNTING CENTERS	DRP
FIXTURE LENGTH	DIM 'B'	FIXTURE LENGTH
DIM 'A'	DIM 'B'	DIM 'A'
49 1/4"	36"	50 1/2"
97 1/4"	84"	98 1/2"

EXTENDED END OPTION		
DCP	MOUNTING CENTERS	DRP
FIXTURE LENGTH	DIM 'B'	FIXTURE LENGTH
DIM 'A'	DIM 'B'	DIM 'A'
57"	36"	57"
105"	84"	105"

PAL RESERVES THE RIGHT TO CHANGE PRODUCT DESIGN AND SPECIFICATIONS. CONTACT FACTORY FOR MOST RECENT PRODUCT INFORMATION.

